

POE

keiga

ED-Series Amplifiers

2ch 22w PoE+ Category

25 Years of *Reliability*

AUDIO AMPLIFIER & IOT DEVICE ODM / JDM / OEM

SOFTWARE / HARDWARE / MANUFACTURING



© 2021 KEIGA ELECTRONIC INC. 101 v.1

2ch 22w PoE Dante® Amplifier

PoE / PoE+

IEEE 802.3af/at

AES67 Compliance

Dante Ultimo™

Audio DSP

5 LED status

Display

(PoE status, CH1 Peak, CH1 Signal, CH2 Peak, CH2 Signal)

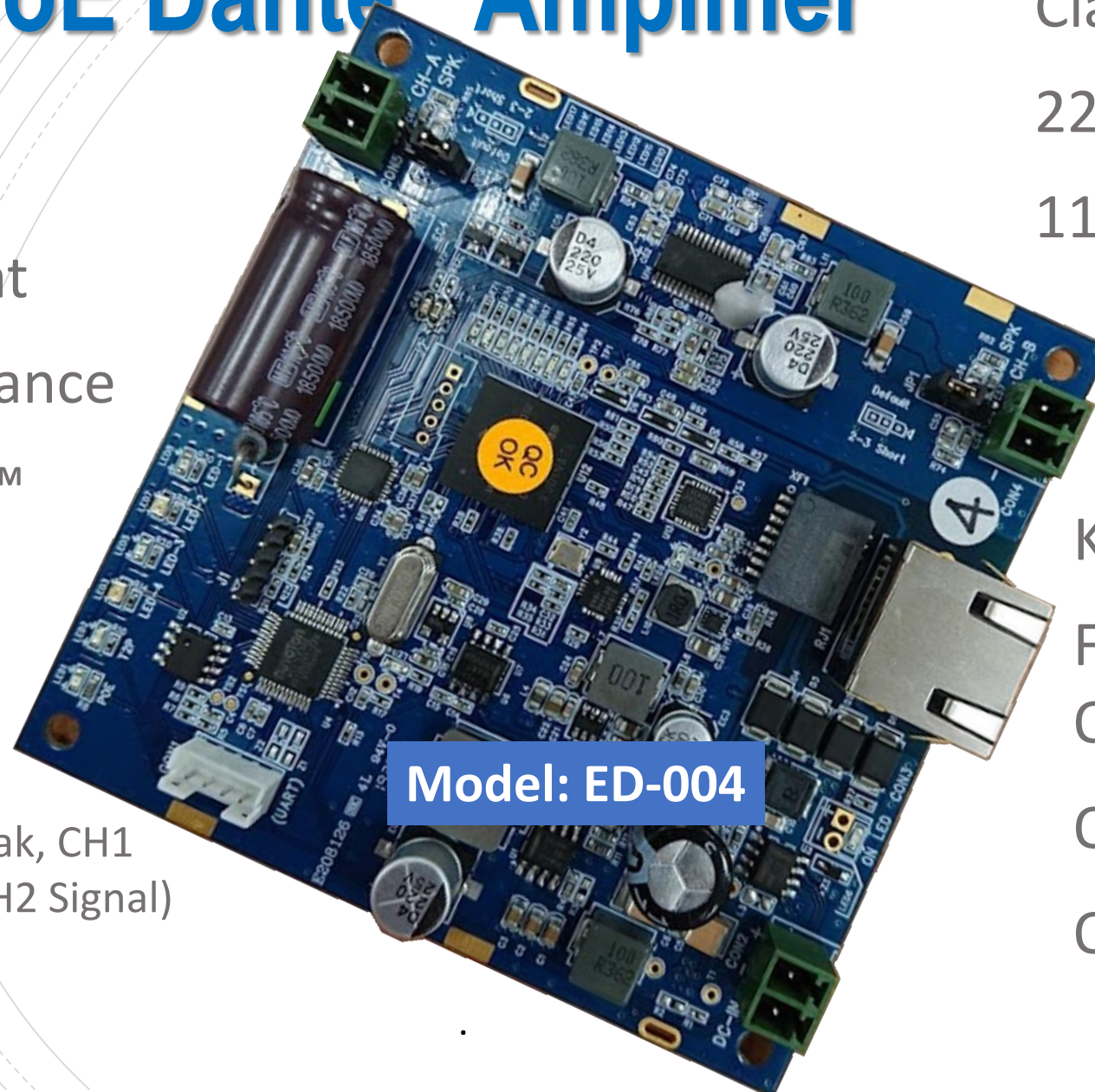

Model: ED-004

Class D Amplifier

22-watt @4Ω bridged

11-watt x 2ch @8Ω

KAP™ software

Find-me, OTP, OCT,
OVP, Auto Recovery

Optional 24V in

Optional UART

2ch 22w PoE Dante® Amplifier

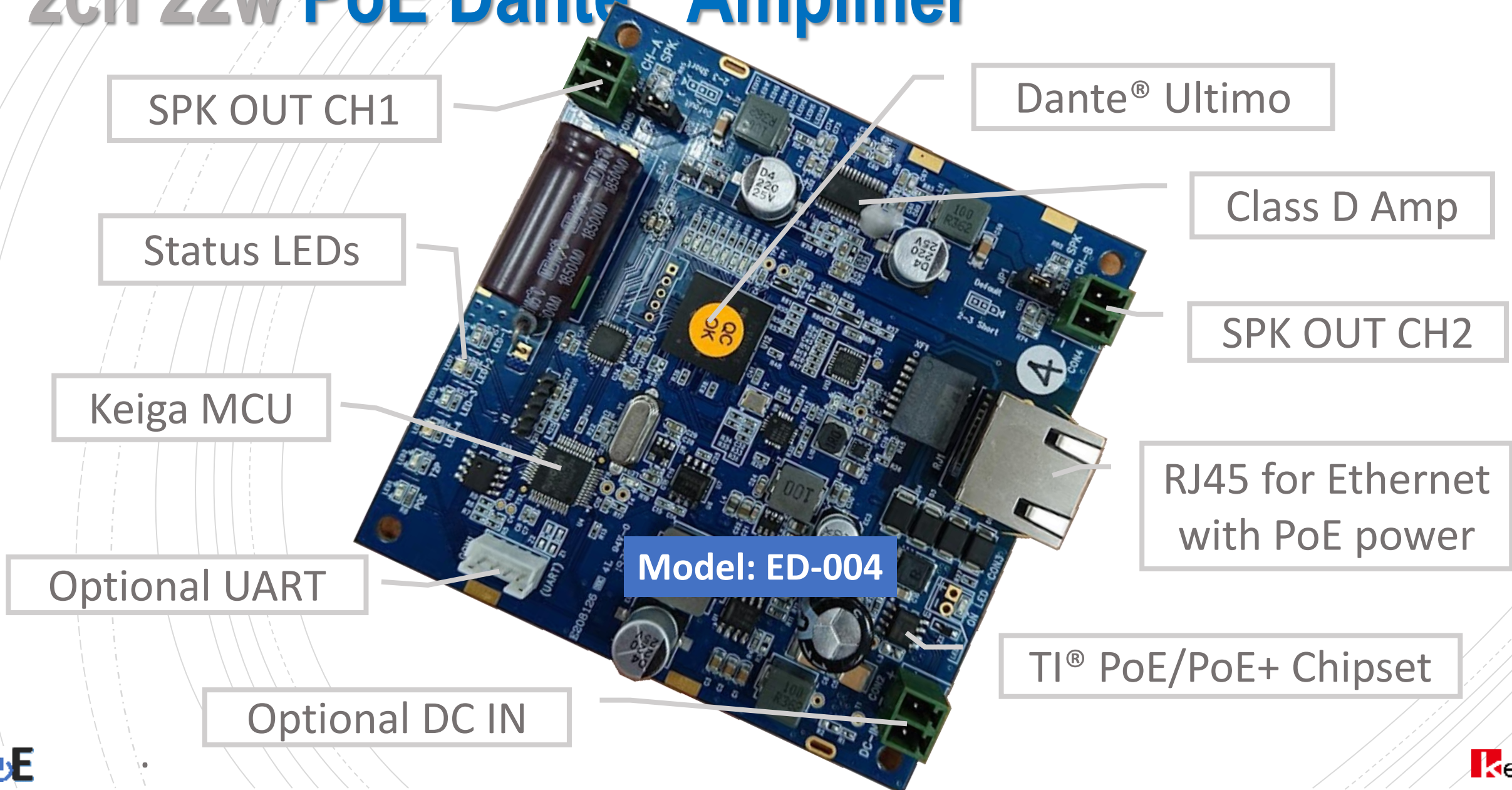

ED-004 Stereo Application

— Analog audio

— Cat5/6 with PoE

PoE / PoE+ Switch

Dante[®]
Audio Network

100 meters max.



2 x 10W Stereo
Passive Speakers

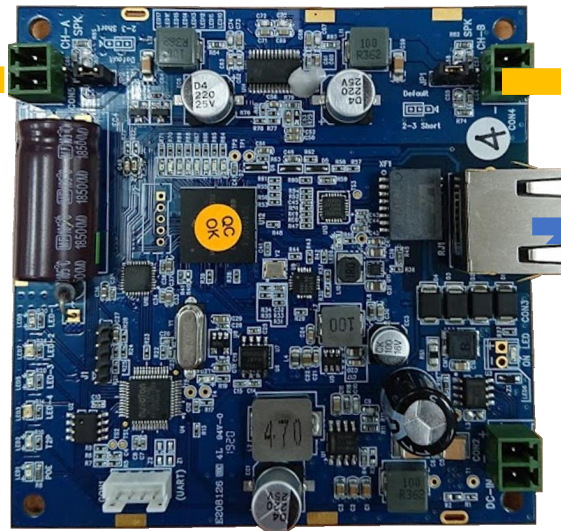

ED-004

- Small Conference room
- Hotel Room
- Entertainment
- Public Signage Sound
- Kiosk
- Advertising Display
- etc.

ED-004 Mono Application

— Analog audio

— Cat5/6 with PoE

PoE / PoE+ Switch

Dante[®]
Audio Network

100 meters max.



20W Passive Speakers

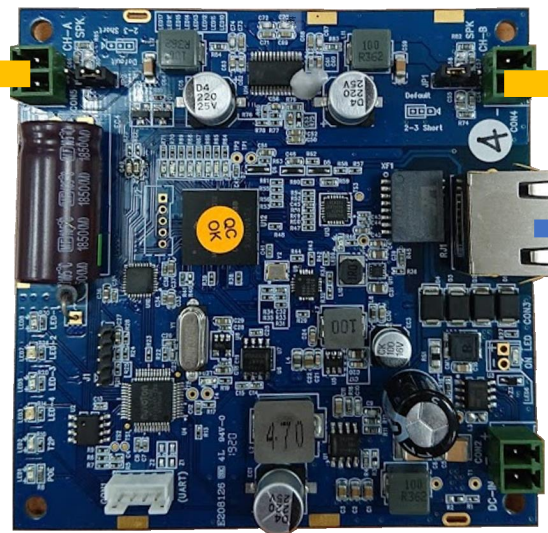

ED-004

- Paging System
- Ambient Sound System
- Fire Alarm
w/Announcement
- Sound Masking System
- etc.

Comes with Exclusive Software **KAP™**

- Volume Control
- Configurations Save & Recall
- Parametric EQ Control
- Auto Discovery
- Filter Respond Adjustment
- Find Me Function
- Power Control and more

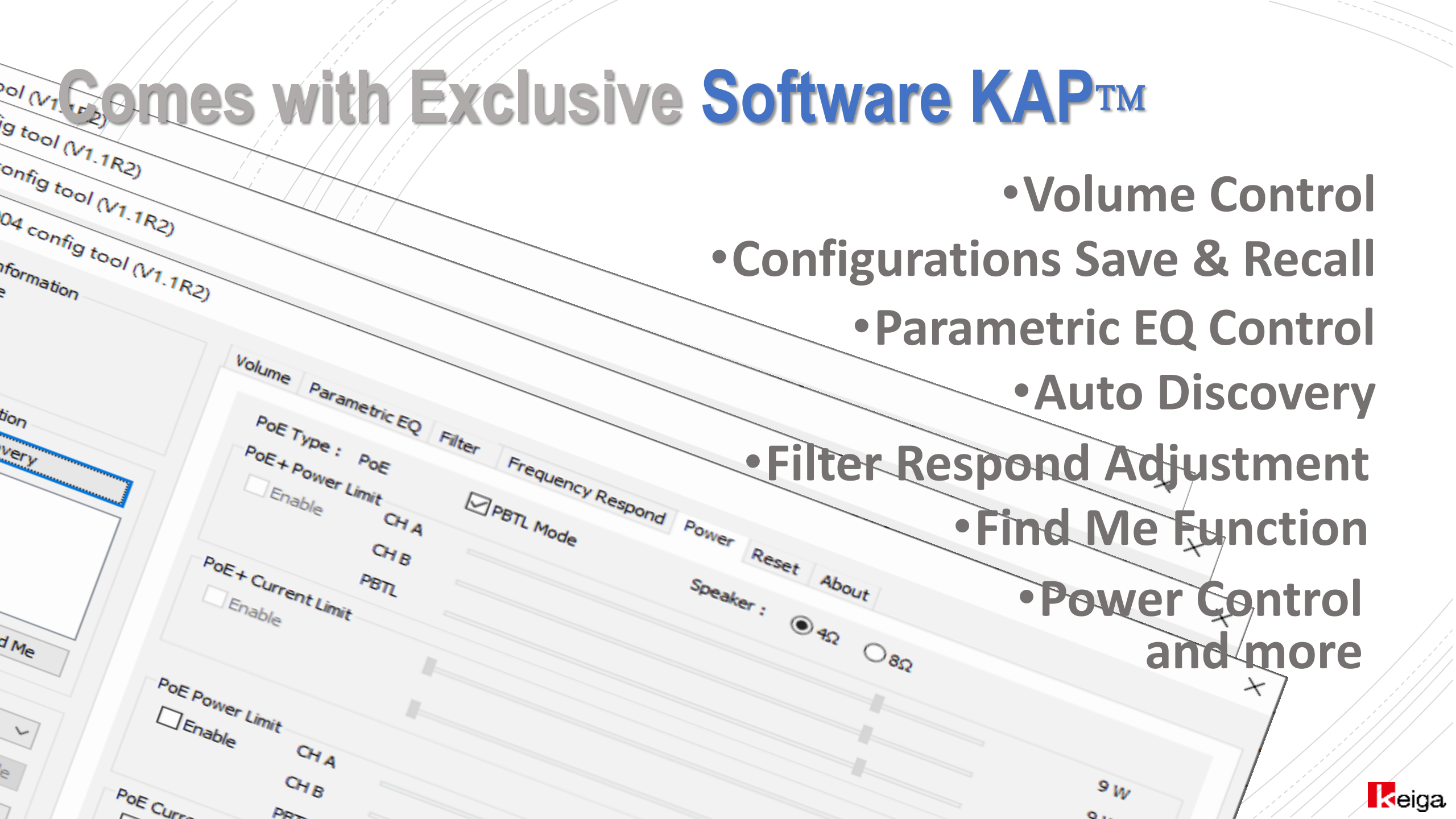

Ready to be Customized

- Keiga's PoE Amp board can be easily customized
- We will re-layout to your speaker's enclosure
- Hidden PoE Amp board inside of your speaker.



ED-22 the ED-004 Inside

- Standalone format ready for your branding
- Able to connect to one and more speakers
- Easily concealed with the ceiling or wall speakers
- Flexible installation for area speakers



Keiga's PoE Audio Ecosystem



Analog audio
Cat5/6
Cat5/6 with PoE
2021 v.3



ED Series Family:

- **PoE+ 2ch 22W:** ED-004, ED-22, ED-010a
- **PoE++ 2ch 71W:** ED-005, ED-009, ED-71
- **PoE++ 4ch 71W:** ED-008, ED-010b
- **PoE++ Injector:** EI-90
- **PoE+ Splitter:** ESDC

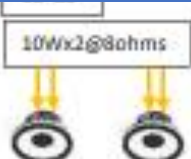
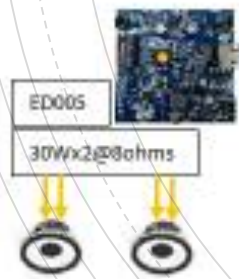
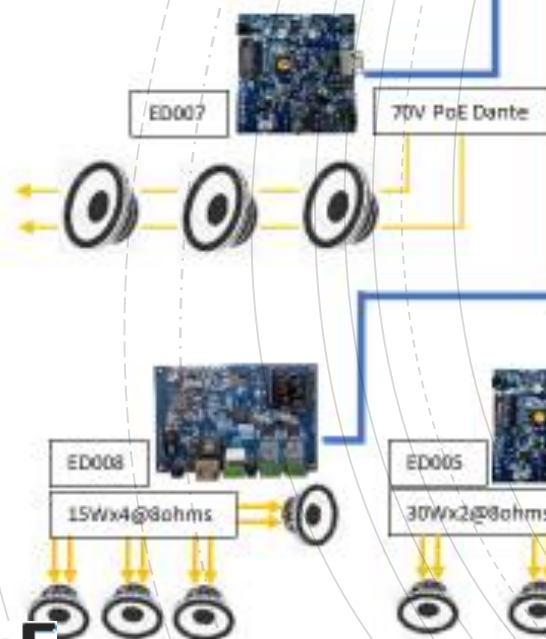
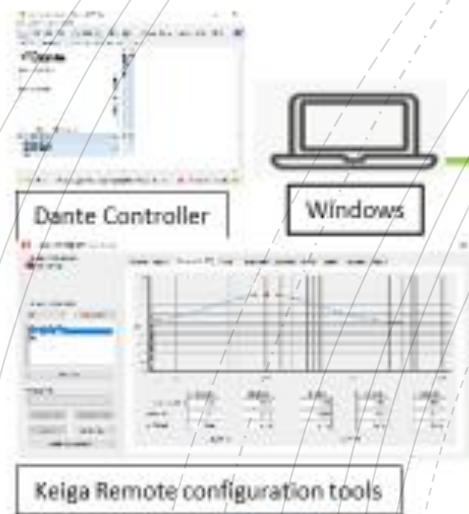



Electronic Inc.

For more product
information, please contact
US....

Keiga.com.tw

Global Integrator:

John Tepley

EMS Integrators

johnt@emsintegrators.com

US Office:

Mal Hollombe

US Advisor

mal@Keiga.com.tw

Taiwan Office:

YF Tsai

PM Director

yftsai@keiga.com.tw

**LET'S DO BUSINESS.
THANK YOU!**